

# *Citation*

## Models #2001, 2001ST, 2001BN

### Instruction Manual









 **GOLD MEDAL**®

**FUNFOOD EQUIPMENT AND SUPPLIES**

Cincinnati, OH 45241-4807 USA

# SAFETY PRECAUTIONS

	<p style="text-align: center;"><b>⚠ DANGER</b></p> <p>Machine <b>MUST</b> be properly grounded to prevent electrical shock to personnel. Failure to do so could result in serious injury, or death. Do <b>NOT</b> immerse the kettle, warmer, or any other part of this equipment in water. Always unplug the equipment before cleaning or servicing. Do not use excessive water when cleaning.</p>
	<p style="text-align: center;"><b>⚠ WARNING</b></p> <p>To avoid serious burns, do <b>NOT</b> touch the kettle while it is hot.</p>
	<p style="text-align: center;"><b>⚠ WARNING</b></p> <p><b>ALWAYS</b> wear safety glasses when servicing this equipment.</p>
	<p style="text-align: center;"><b>⚠ WARNING</b></p> <p>Any alterations to this equipment will void the warranty and may cause a dangerous situation. <b>NEVER</b> make alterations to the equipment. Make sure all machine switches are in the off position before plugging the equipment into the receptacle.</p>
	<p style="text-align: center;"><b>⚠ CAUTION</b></p> <p>This equipment is sold for commercial use only. This equipment is <b>NOT</b> to be used by the general public for home use. Do <b>NOT</b> allow direct contact with this equipment and the general public when used in food service locations. Only personnel that are trained and familiar with the equipment should operate the equipment. Carefully read all installation instructions before operating the equipment.</p>
	<p style="text-align: center;"><b>⚠ CAUTION</b></p> <p>This machine is <b>NOT</b> to be operated by minors. Minors are classified as anyone under the age of 18.</p>

## NOTE

The information, specifications and illustrations contained in this manual represent the latest data available at time of publication. Right is reserved to make changes as required at the discretion of Gold Medal Products Company without notice.

## Forward

This manual covers the 16oz. Citation Popcorn Machine, model number 2001, 2001BN, and 2001ST.

## Installation Instructions

### Inspection of Shipment:

Unpack all cartons and check thoroughly for any damage that may have occurred during transit. Damage claims should be filed immediately with the transportation company. Gold Medal is not responsible for damage that occurs in transit.

### Setup:

Your new Citation Popcorn Machine is completely assembled and tested at the factory. Remove all packing material and tape before starting operation.

### Electrical Requirements:

The following power supply must be provided:

Model No. 2001 – 2001BN – 2001ST: 1920 Watts, 120 VAC, 16 Amps, 60 Hz.

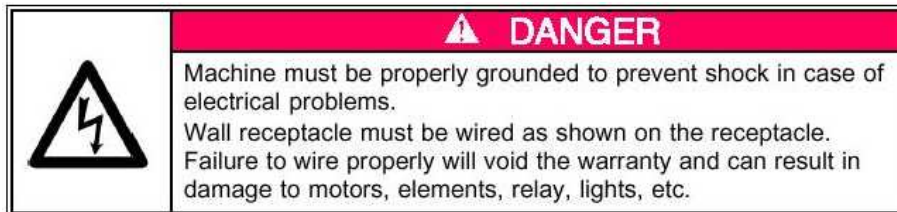

Your electrician must furnish sufficient current for proper machine operation. We recommend this popper be connected to a dedicated 20 amp circuit protected line. Failure to wire properly will void the warranty and can result in damage to the heat elements, light, motor and etc.

It is Gold Medal Products Company's recommendation that this machine be plugged directly into a wall outlet. The use of extension cords is not recommended due to safety reasons and the popper's performance will be sacrificed/reduced.

### Before You Plug In Machine:

1. Make sure that the wall outlet can accept the three (3) prong grounded plug on the power supply cord.
2. The wall outlet must have the proper polarity. If in doubt, have a competent electrician inspect the outlet and correct if necessary.
3. **DO NOT** use a three (3) prong grounded to two (2) prong un-grounded adapter.

## FINAL PREPARATIONS

The popcorn machine was adjusted, inspected, and tested before it left the factory. After removing machine from shipping box, remove all tape and packing material in or on the machine before beginning operation.

## **OPERATING INSTRUCTIONS**

### Controls and their functions



#### **LIGHT SWITCH**

Turns on all of the lights, interior, and dome on your popcorn machine.

#### **WARMER SWITCH**

Operates the forced air popcorn crisping system.

#### **KETTLE HEAT SWITCH**

Operates the heating elements in the popping kettle.

#### **KETTLE MOTOR SWITCH**

Operates the kettle agitator motor, as well as the exhaust blower in the roof of the machine.



Light Switch  
p/n 42798

Warmer Switch  
p/n 42798

Kettle Motor  
Switch  
p/n 42798

Kettle Heat Switch  
p/n 42798

## **Amount of Popcorn and Oil:**

The Citation popper is equipped with a sixteen ounce corn measure cup. Gold Medal Products Company recommends the use of flavored and colored coconut oil. Coconut oil does not leave black deposits in the kettle like other oils.

Corn Charge:           16 Oz. (473 ml)

Oil Charge:            4-5 ounces

Flavacol (Salt):      1 ½ Tablespoon (20 cc) (Use the supplied Salt Scoop)

## **Popping Instructions:**

1. Turn both the **KETTLE HEAT** and **KETTLE MOTOR** switches **ON**.
2. Test pop three (3) kernels of corn and one ounce (1 Oz.) of popping oil. When the kernels pop, the kettle is ready for use.
3. Load both a full corn/oil charge and Flavacol Seasoning Salt into the kettle. Close the lids.
4. When the corn has finished popping, gently dump the kettle.
5. Repeat the cycle, starting with step number 3, until the desired amount of popcorn has been achieved. Always pop 3 to 5 consecutive batches for the best popcorn.

On the final kettle of corn, it is a good idea to turn the **KETTLE HEAT** switch **OFF** just as the lids are forced open by the popping corn. This procedure saves electricity, and reduces smoke/odor from any oil residue that remains after you have finished popping.

# CLEANING INSTRUCTIONS

## DAILY:

### Clean the Kettle

1. CAUTION: The hot kettle will cause burns if you touch it with your hand. Allow the kettle to cool for at least 1 hour before attempting to clean. Wipe the kettle with a clean cloth.
2. After ending extended use, mix a gallon of Heat'n Kleen solution (2 tablespoons per gallon of water). Add 16 oz. of this solution into the kettle. Turn on the kettle heat. When the water starts to boil, turn off the kettle heat and allow the solution to work over-night.
3. Before next use, dump the solution into a bucket and wipe the inside of the kettle with a clean cloth. Make sure all of the solution goes into the bucket, and that you do not spill any into the interior cabinet of the machine.

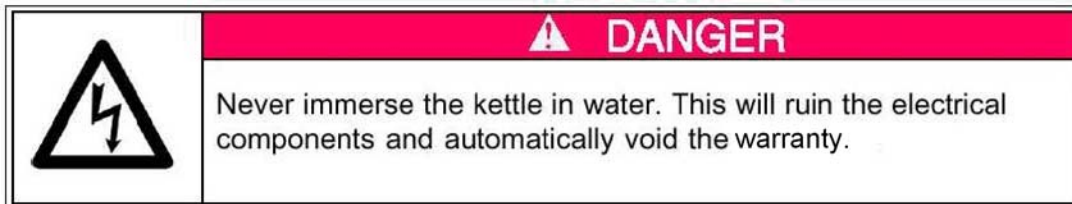

### Clean the Exhaust Filter (Shown on Page 12 of this manual)

Clean the Exhaust Filter at least once a week by following these simple instructions:

1. Pull the filter out.
2. Wash in warm soap and water.
3. Allow filter to air dry, then re-install.

### Clean the Popcorn Machine

1. Wipe the stainless steel parts with a clean cloth and cleaner designed for stainless steel. ***Do not use oven cleaners, as they will damage parts of the machine.***
2. Ammonia cleaners will damage the plastic doors. ***Use only non-ammonia cleaners, such as Gold Medal's – Watchdog Glass Cleaner – item number 2588.***

# MAINTENANCE INSTRUCTIONS

	<b>⚠ DANGER</b>
	Improper installation, adjustment, alteration, service or maintenance can cause property damage, injury, or death. Read the Installation, Operating, and Maintenance Instructions thoroughly. Installation should be performed by a certified electrician.

	<b>⚠ WARNING</b>
	Adequate eye protection must be used when servicing this equipment to prevent the possibility of injury.

	<b>⚠ CAUTION</b>
	THE FOLLOWING SECTIONS OF THIS MANUAL ARE INTENDED ONLY FOR QUALIFIED SERVICE PERSONNEL WHO ARE FAMILIAR WITH ELECTRICAL EQUIPMENT. THESE ARE NOT INTENDED FOR THE OPERATOR.

# TROUBLESHOOTING

Below are some common issues you may encounter, along with basic trouble shooting steps to resolve them.

## EXPERIENCING LONG POPPING CYCLES

If your pop cycle is longer than 4 minutes, it can be the result of several things:

- A. **LOW VOLTAGE** - If the machine is operated on low voltage, this could cause the kettle not to reach the proper operating temperature. Voltage must be at least 110v.
- B. **INADEQUATE SUPPLY LINES** - Inadequately sized electrical supply lines, in addition to being a fire hazard, would also prevent the kettle from reaching the proper operating temperature. Check with a qualified electrician.
- C. **INFERIOR CORN** - Inferior quality corn would result in longer popping cycles. Use only top quality fresh hybrid popcorn from reputable suppliers. Even then, if you let your corn pick up moisture or dry out, your popping cycles will be slow.

## THE KETTLE DOES NOT HEAT

Before you go any further, make sure the kettle lead-in cord is plugged in-

- A. **KETTLE HEAT SWITCH** - Check the voltage to and from the "KETTLE HEAT" switch, and if the switch is defective, replace it. (Repair should only be performed by qualified service personnel.)

## THE MOTOR WILL NOT TURN AGITATOR

**WARNING!** If the kettle agitator shaft is not rotating, **DO NOT** pop corn. Adjust the clearance between the kettle bottom and the stir blade to 1/32" (use a dime). Loosen the set screw in the collars above and below the crossbar and adjust the agitator shaft as necessary. Then re-tighten the set screws in the collars.



# ORDERING SPARE PARTS

1. Identify the needed part by checking it against the photos, illustrations, and/or the parts list.
2. When ordering, please include part number, part name, and quantity needed.
3. Please include the machine's model name, serial number, and date of manufacture (located on the machine nameplate) with your order.
4. Address all parts orders to:

Parts Department  
Gold Medal Products Co.  
10700 Medallion Drive  
Cincinnati, Ohio 45241-4807  
(800) 543-0862  
(513) 769-7676  
Fax: (513) 769-8500

or, place orders at:

E-mail: [info@gmpopcorn.com](mailto:info@gmpopcorn.com)  
Web Page: [www.gmpopcorn.com](http://www.gmpopcorn.com)

# Cabinet Breakdown

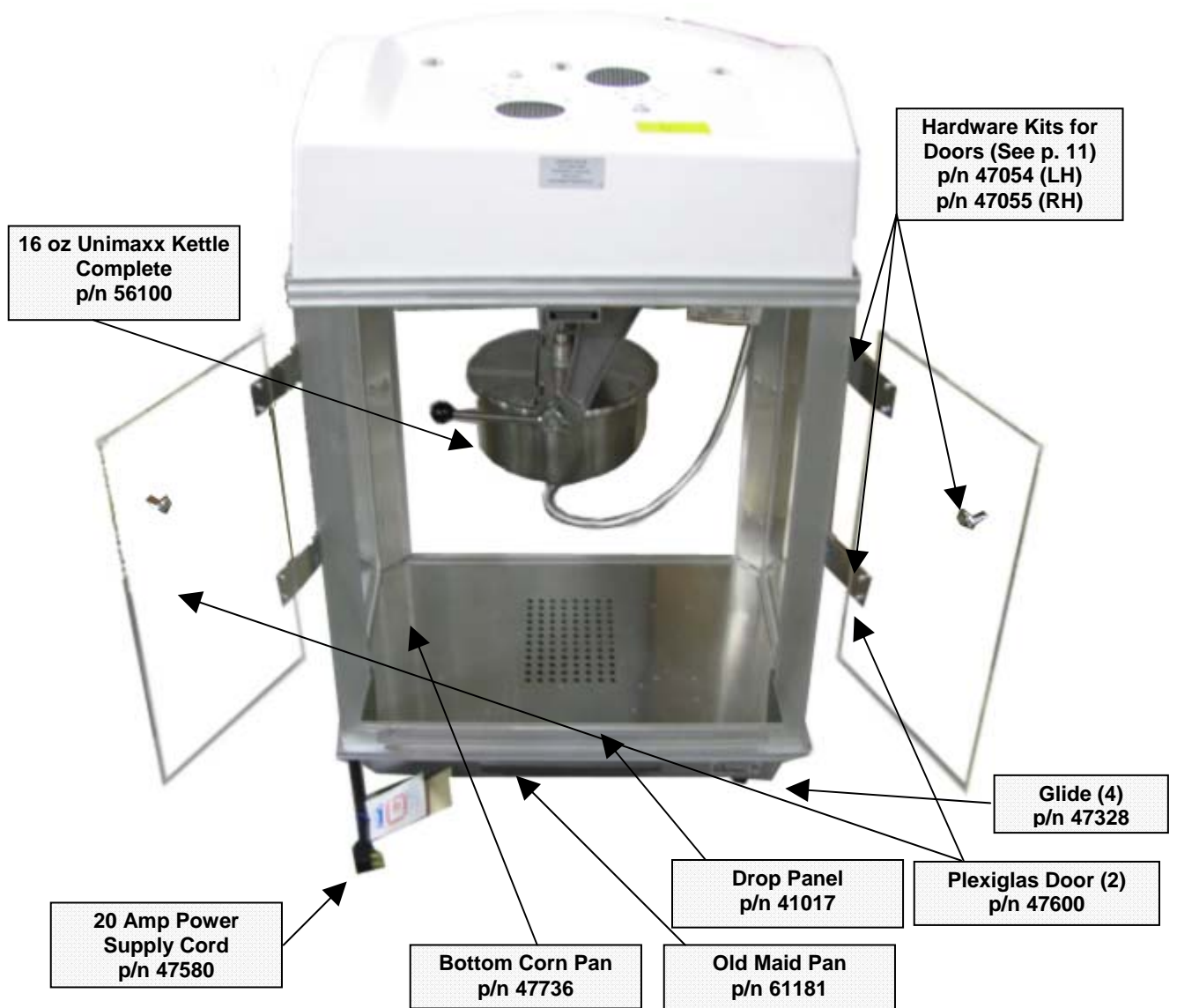

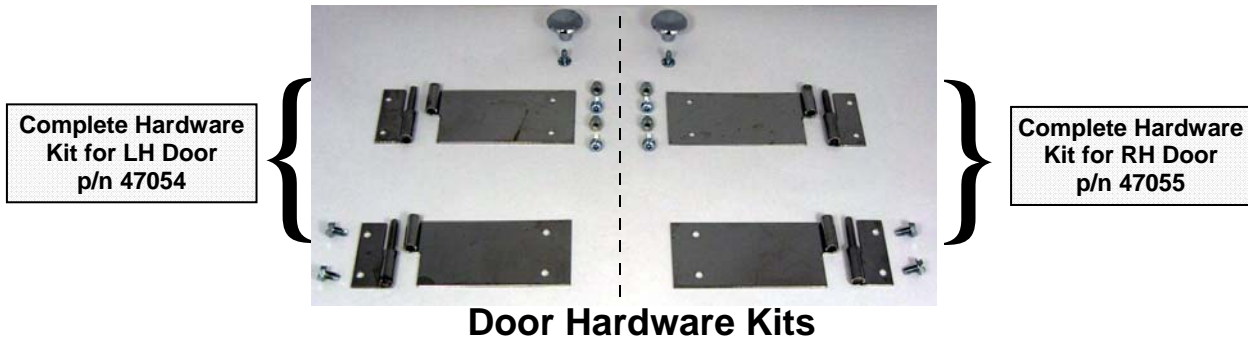

**Individual Hardware Components**

Door Knob	41013
Tee Bolt	75267
LH Male Hinge	41349
8-32 X 3/8" Screws	74141
LH Female Hinge	41352
8-32 Acorn Nut	47702
8-32 X 1/2" Screws	47124
RH Female Hinge	41351
RH Male Hinge	41350

**Cabinet Interior – Ceiling Components**

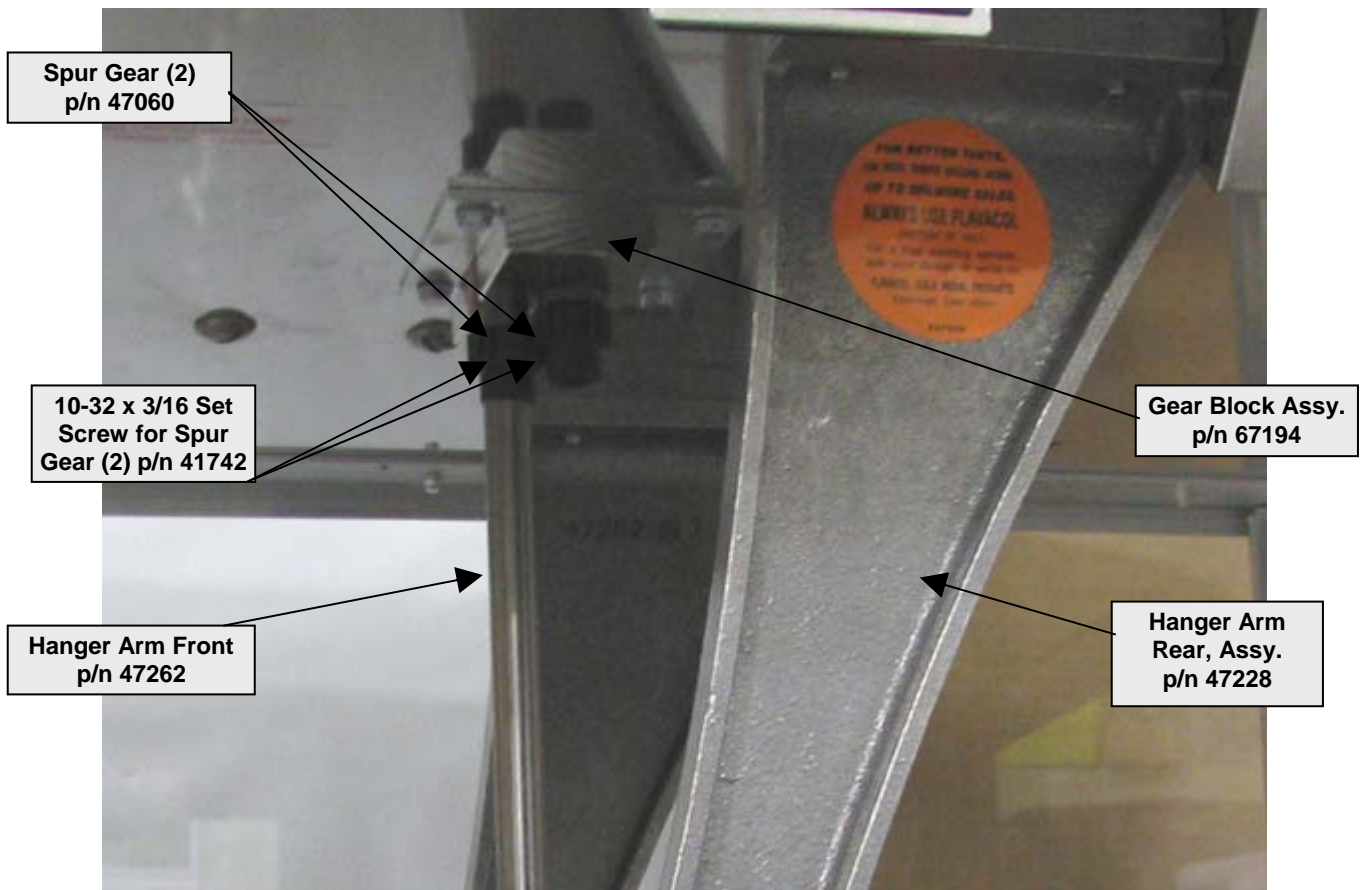

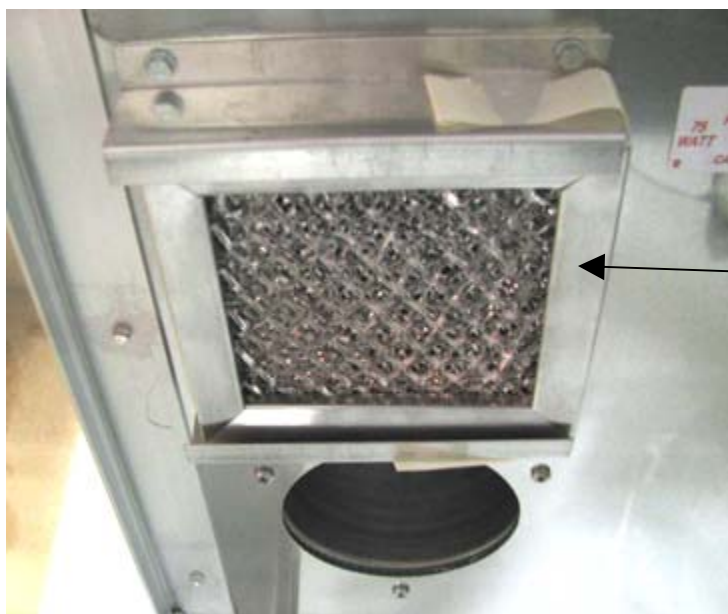

Filter  
p/n 47043

## Heater Blower Components (Assembly p/n 50102L)

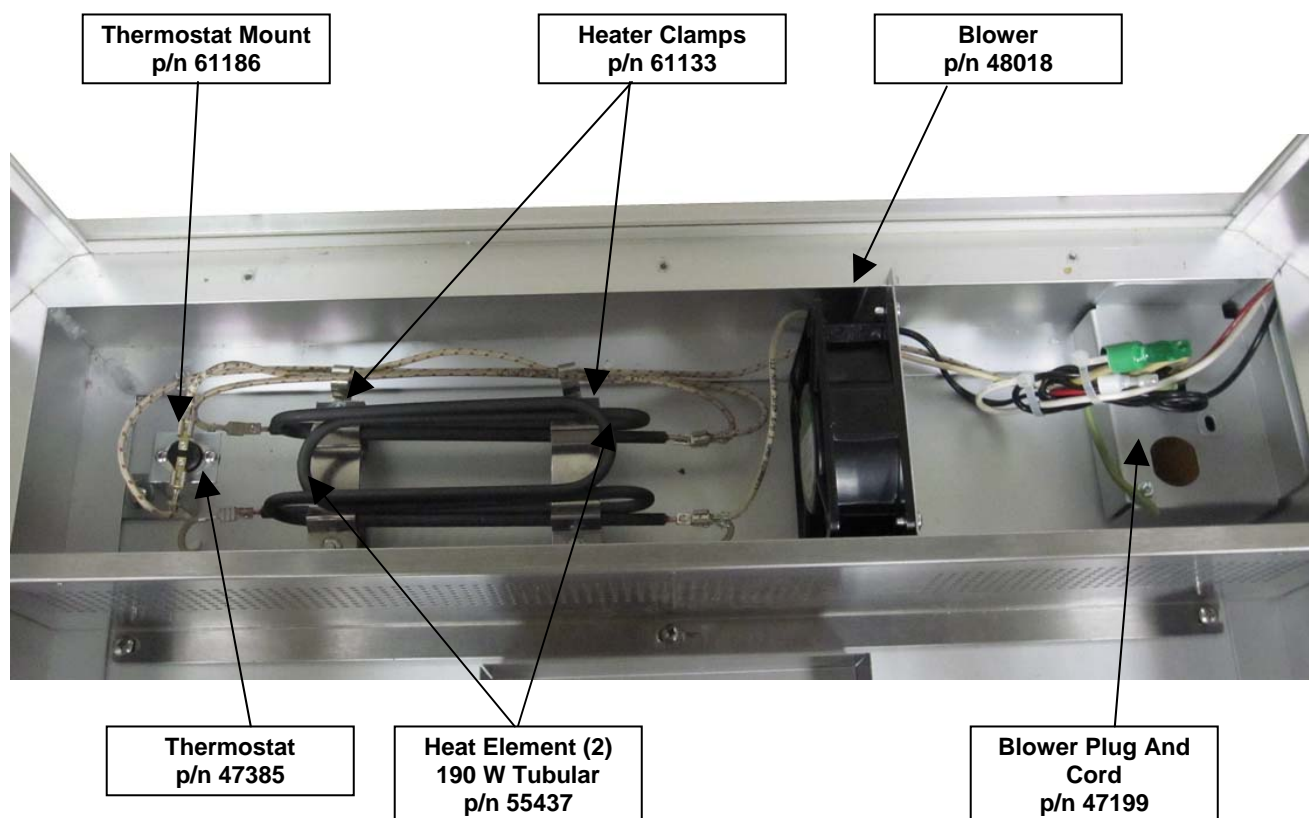

# Kettle Breakdown

# Kettle Complete – P/N 55199

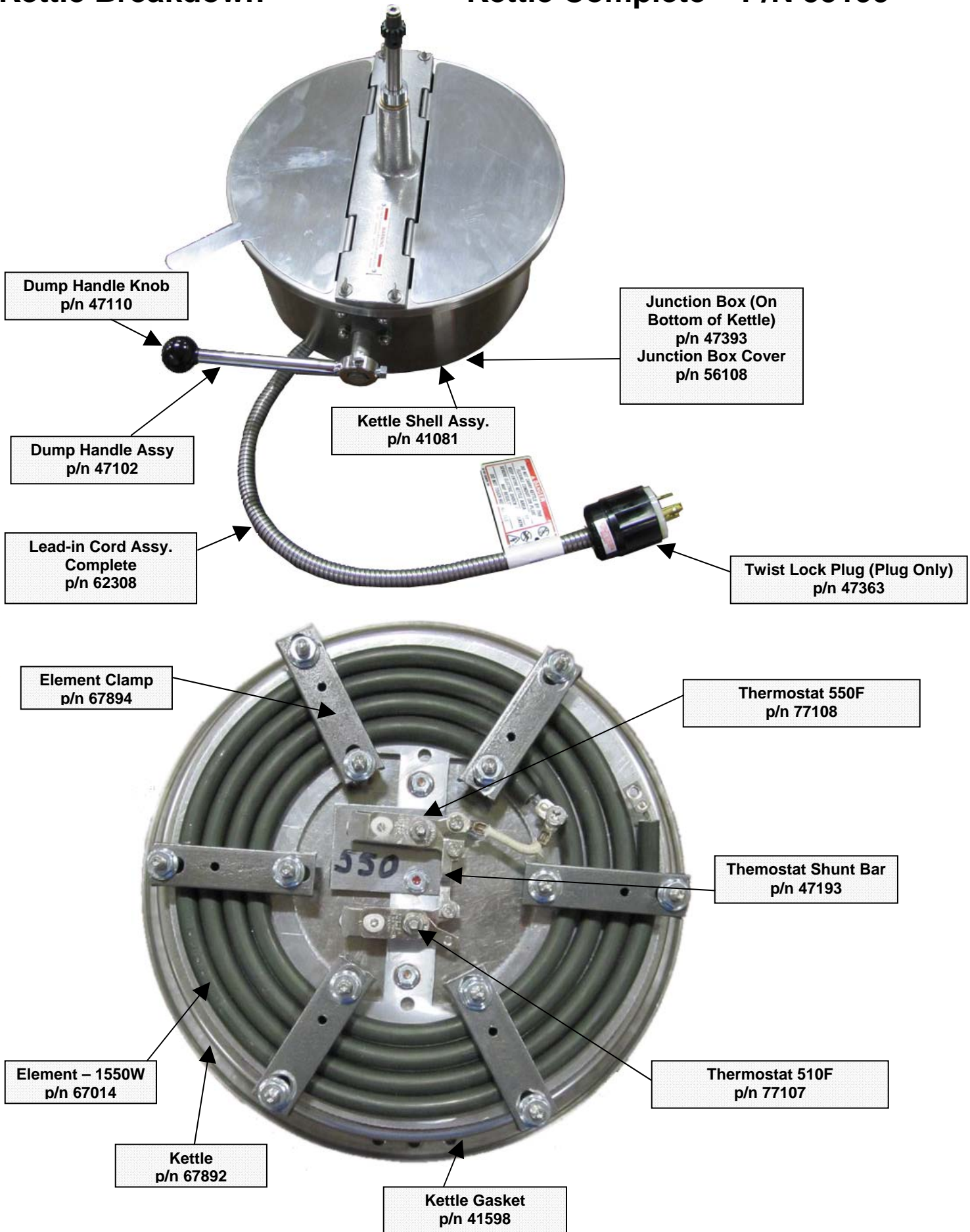

### Lid and Agitator Assembly

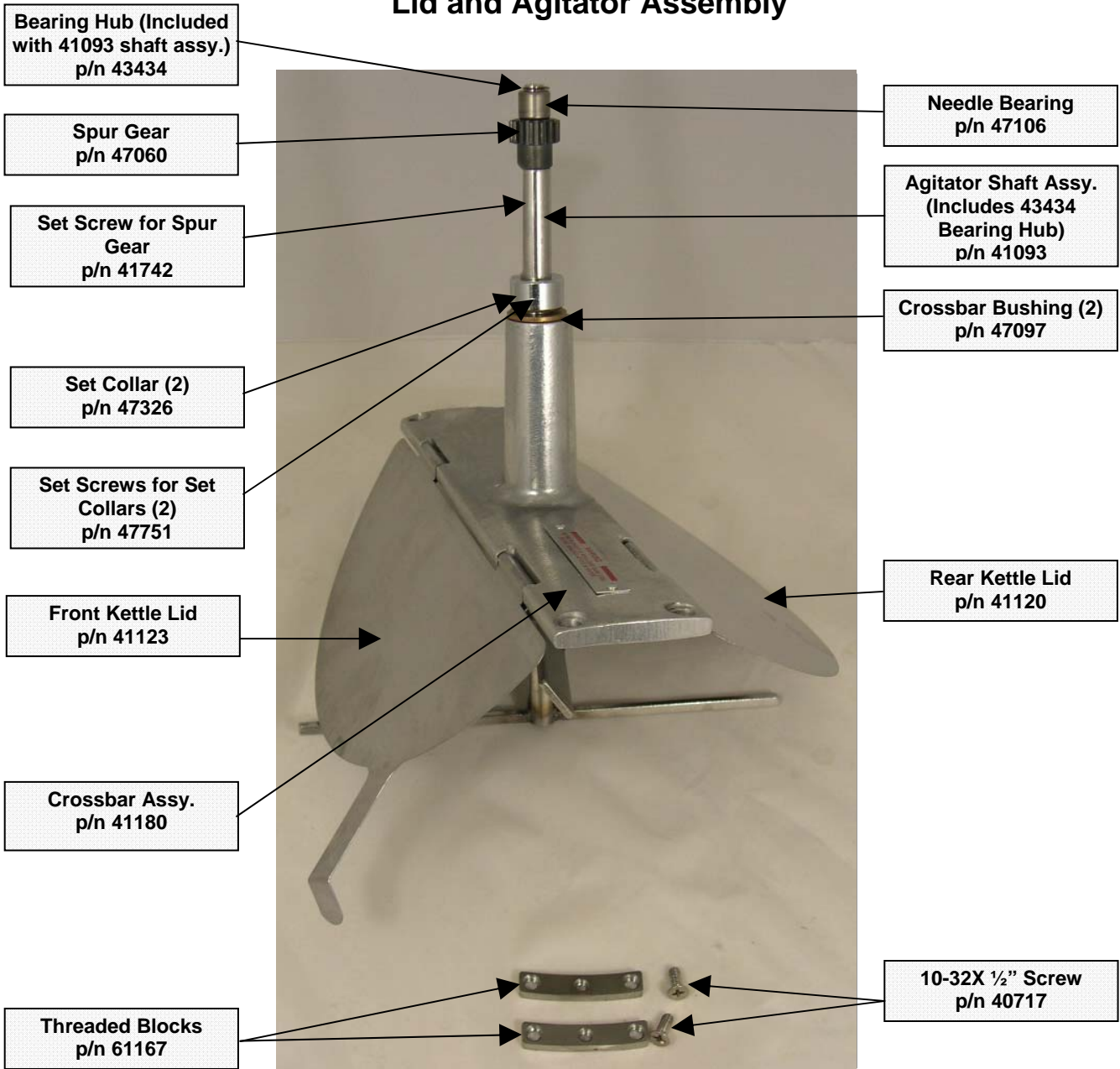

**Lid and Agitator Assembly available complete as P/N 41181**

# Top - Motor Plate Assy.

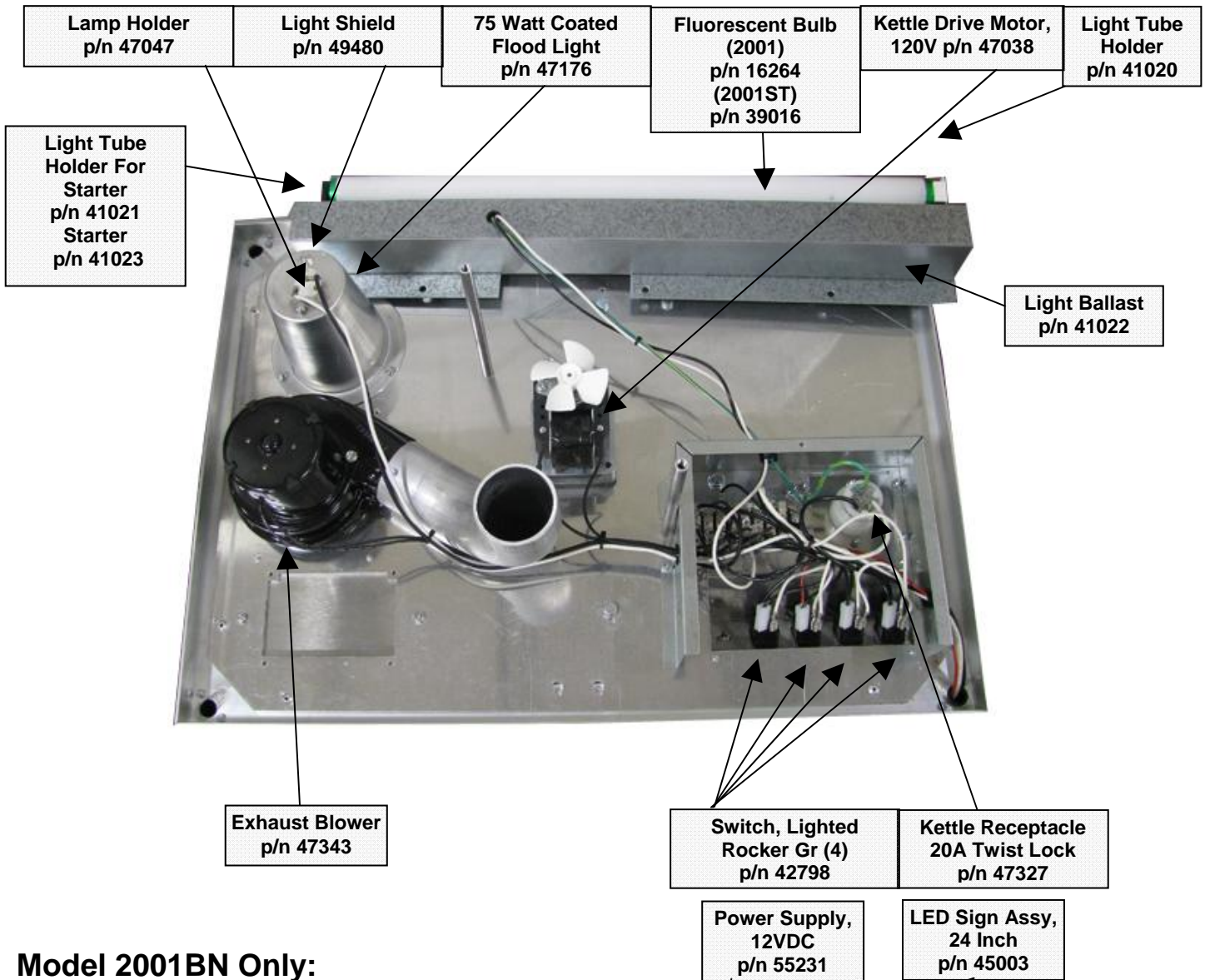

## Model 2001BN Only:

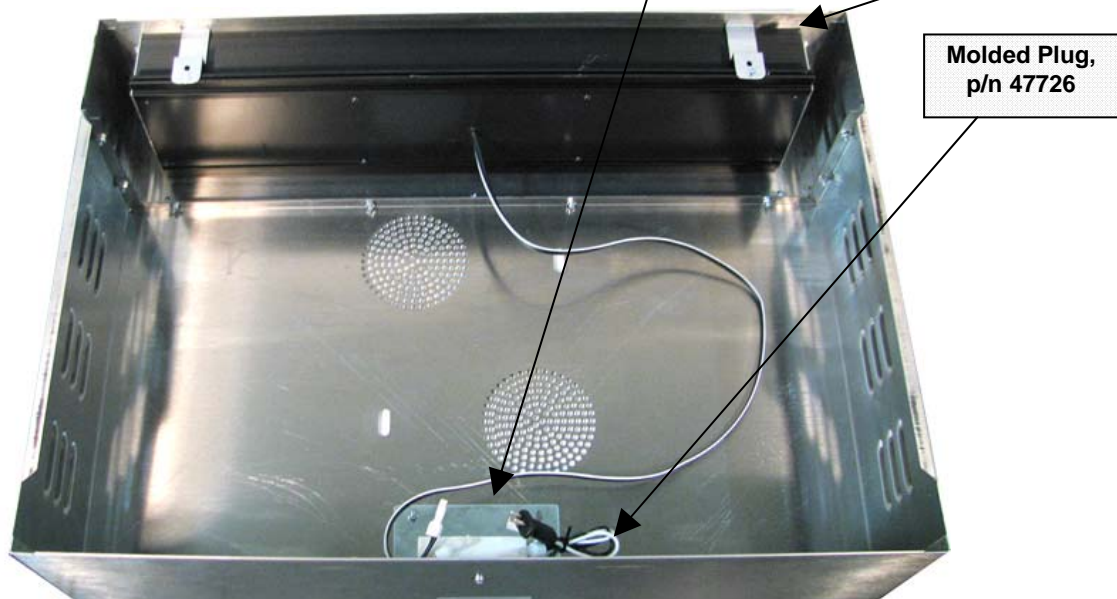

# Electrical Schematic – 2001, 2001BN, 2001ST

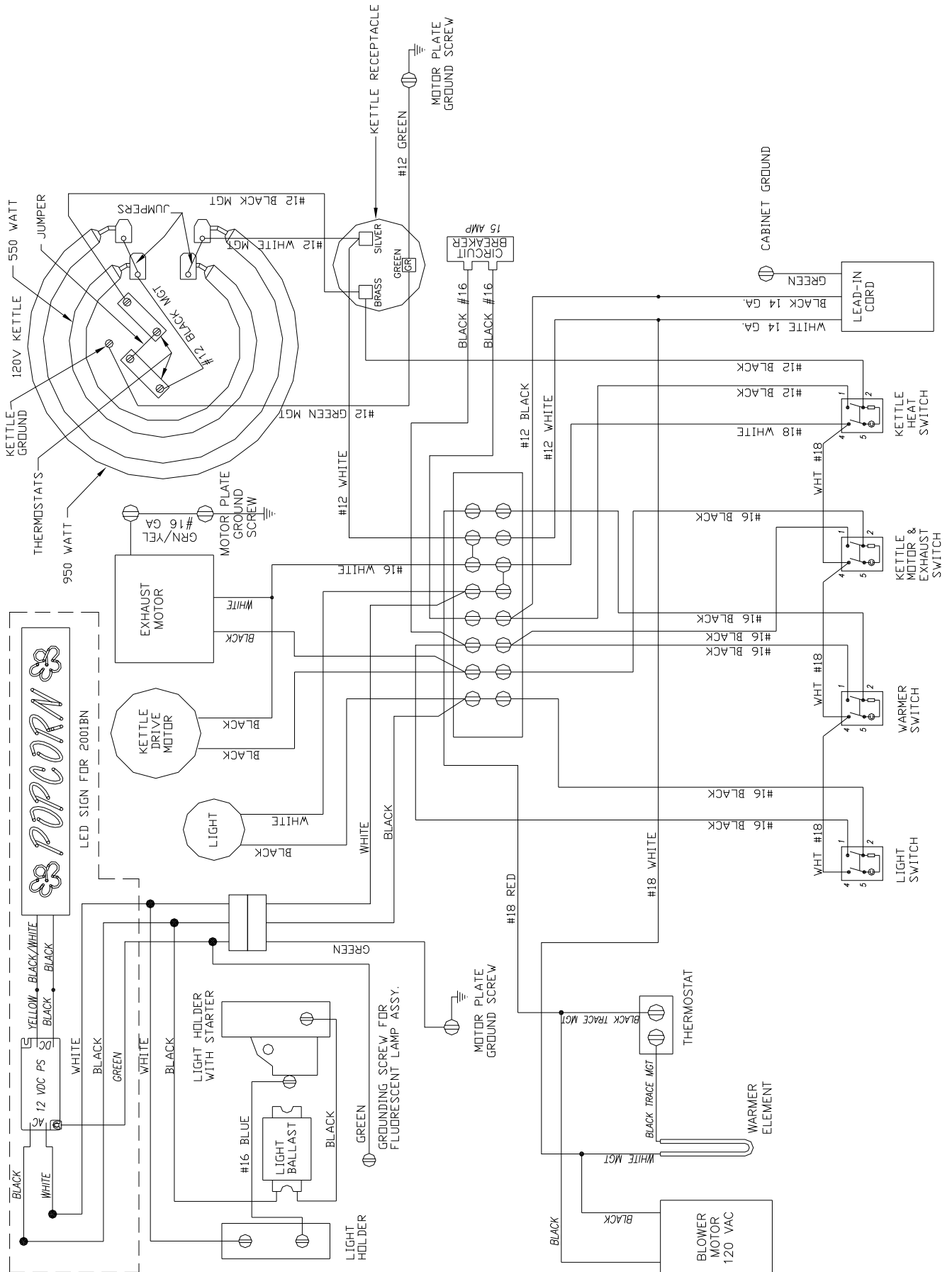



## WARRANTY

WE WARRANT to the original purchaser the Gold Medal equipment sold by us to be free from defects in material or workmanship under normal use and service. Our obligation under this warranty shall be limited to the repair or replacement of any defective part for a period of six (6) months from the date of sale to the Original Purchaser with regard to labor and two (2) years with regard to parts and does not cover damage to the equipment caused by accident, alteration, improper use, voltage, abuse, or failure to follow instructions.

THIS WARRANTY IS IN LIEU OF ALL OTHER WARRANTIES EXPRESSED OR IMPLIED, AND OF ALL OTHER OBLIGATIONS OR LIABILITIES ON OUR PART, INCLUDING THE IMPLIED WARRANTY OF MERCHANTABILITY. THERE ARE NO WARRANTIES WHICH EXTEND BEYOND THE DESCRIPTION ON THE FACE HEREOF. We neither assume, nor authorize any other person to assume for us, any other obligation or liability in connection with the sale of said GOLD MEDAL equipment or any part thereof.

The term "Original Purchaser" as used in this warranty shall be deemed to mean that person, firm, association, or corporation who was billed by the GOLD MEDAL PRODUCTS COMPANY, or their authorized distributor for the equipment.

THIS WARRANTY HAS NO EFFECT AND IS VOID UNLESS THE ORIGINAL PURCHASER FIRST CALLS GOLD MEDAL PRODUCTS COMPANY AT 1-800-543-0862 TO DISCUSS WITH OUR SERVICE REPRESENTATIVE THE EQUIPMENT PROBLEM, AND, IF NECESSARY, FOR INSTRUCTIONS CONCERNING THE REPAIR OR REPLACEMENT OF PARTS.

*NOTE: This equipment is manufactured and sold for commercial use only.*



**GOLD MEDAL PRODUCTS COMPANY**

**10700 Medallion Drive**

**Cincinnati, Ohio 45241-4807 USA**

**[www.gmpopcorn.com](http://www.gmpopcorn.com)**

**Phone: 1-800-543-0862**

**Fax: 1-800-542-1496**

© The text, descriptions, graphics and other material in this publication are the proprietary and exclusive property of Gold Medal Products Company and shall not be used, copied, reproduced, reprinted or published in any fashion, including website display, without its express written consent.